

Silicon PNP Epitaxial Planar Transistor

BTB1238AL3

BV_{CEO}	-240V
I_C	-1A
$V_{CESAT(Max)}$	-0.3V

Description

- High BV_{CEO}
- High current capability
- RoHS compliant package
- Pb-free lead plating and halogen-free package

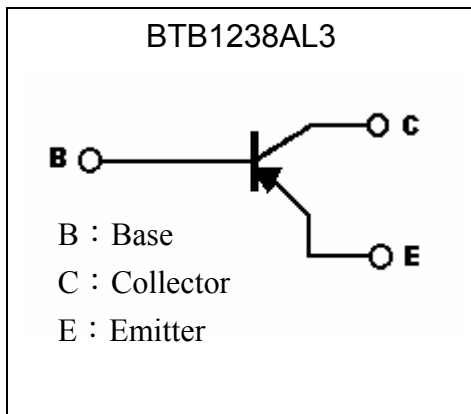
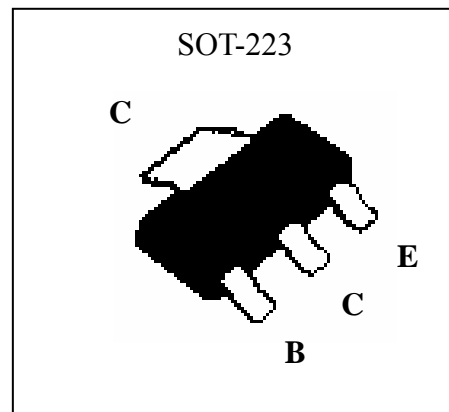
Symbol

Outline

Absolute Maximum Ratings ($T_a=25^{\circ}C$, unless otherwise specified)

Parameter	Symbol	Limits	Unit
Collector-Base Voltage	V_{CBO}	-240	V
Collector-Emitter Voltage	V_{CEO}	-240	V
Emitter-Base Voltage	V_{EBO}	-7	V
Collector Current (DC)	I_C	-1	A
Collector Current (Pulse)	I_{CP}	-2	A
Base Current	I_B	-200	mA
Power Dissipation	P_D	3 (Note)	W
Thermal Resistance, Junction to Ambient	$R_{\theta JA}$	41.7	$^{\circ}C/W$
Operating Junction and Storage Temperature Range	$T_j ; T_{stg}$	-55 ~ +150	$^{\circ}C$

Note: The power which can be dissipated assuming the device is mounted in a typical manner on a P.C.B. with copper equal to 4 square inch minimum.

Characteristics (Ta=25°C, unless otherwise specified)

Symbol	Min.	Typ.	Max.	Unit	Test Conditions
BV_{CBO}	-240	-	-	V	$I_C = -50\mu A, I_E = 0$
BV_{CEO}	-240	-	-	V	$I_C = -1mA, I_B = 0$
BV_{EBO}	-7	-	-	V	$I_E = -50\mu A, I_C = 0$
I_{CBO}	-	-	-100	nA	$V_{CB} = -240V, I_E = 0$
I_{EBO}	-	-	-100	nA	$V_{EB} = -7V, I_C = 0$
* $V_{CE(sat)}$	-	-	-0.3	V	$I_C = -500mA, I_B = -50mA$
* $V_{CE(sat)}$	-	-	-3	V	$I_C = -1A, I_B = -100mA$
* $V_{BE(sat)}$	-	-	-1.1	V	$I_C = -1A, I_B = -100mA$
* $V_{BE(on)}$	-	-	-0.9	V	$V_{CE} = -5V, I_C = -150mA$
h_{FE1}	120	-	400	-	$V_{CE} = -5V, I_C = -100mA$
h_{FE2}	60	-	-	-	$V_{CE} = -5V, I_C = -500mA$
f_T	-	140	-	MHz	$V_{CE} = -5V, I_C = -150mA$
Cob	-	27	-	pF	$V_{CB} = -10V, I_E = 0, f = 1MHz$

 *Pulse Test: Pulse Width $\leq 380\mu s$, Duty Cycle $\leq 2\%$
Ordering Information

Device	Package	Shipping
BTB1238AL3-0-T3-G	SOT-223 (Pb-free lead plating and halogen-free package)	2500 pcs / Tape & Reel

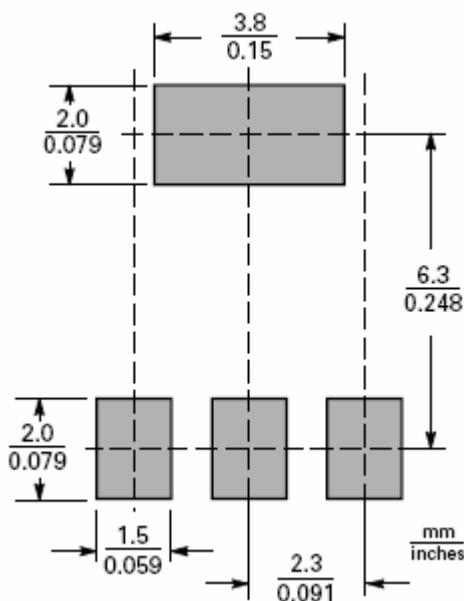
Recommended soldering footprint

Typical Characteristics

Current Gain vs Collector Current

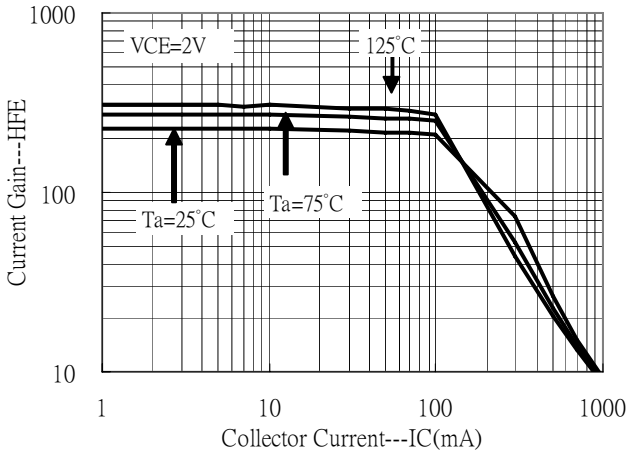

Current Gain vs Collector Current

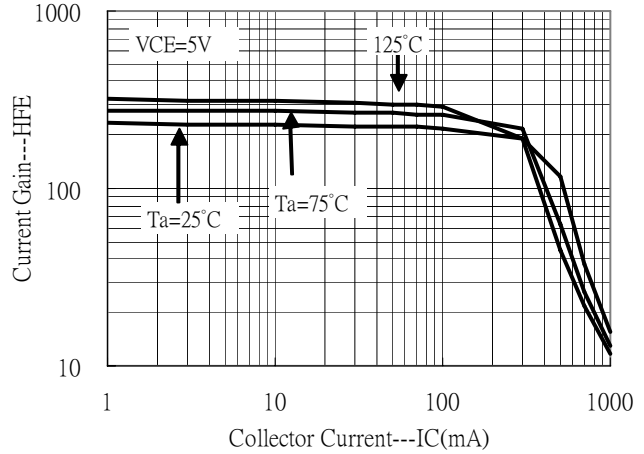

Saturation Voltage vs Collector Current

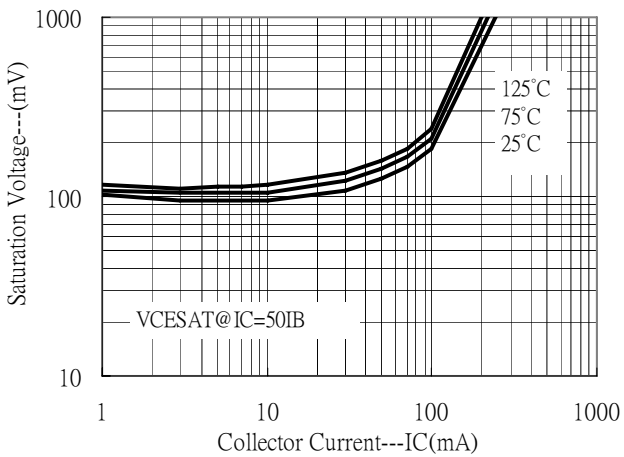

Saturation Voltage vs Collector Current

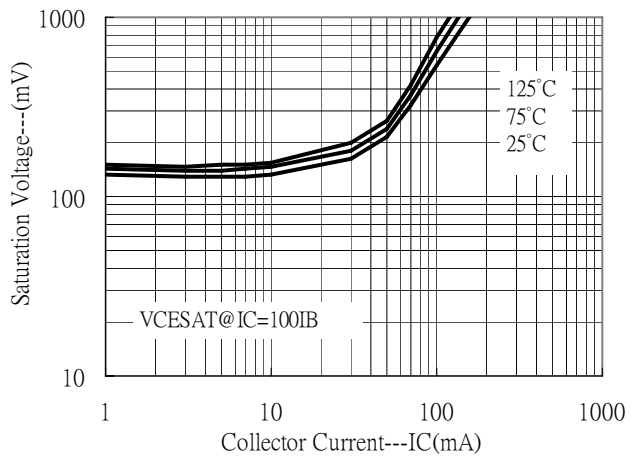

Saturation Voltage vs Collector Current

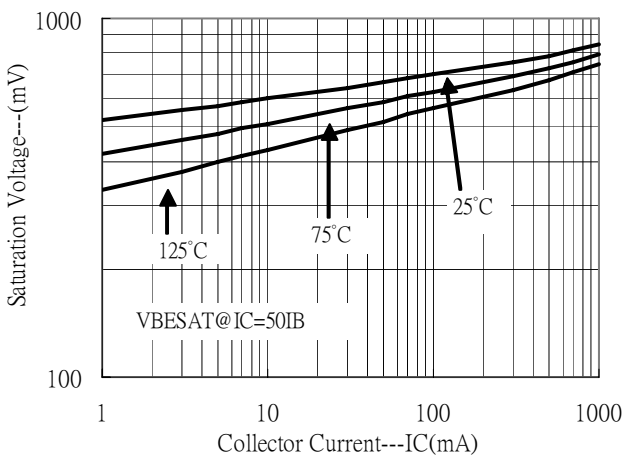

On Voltage vs Collector Current

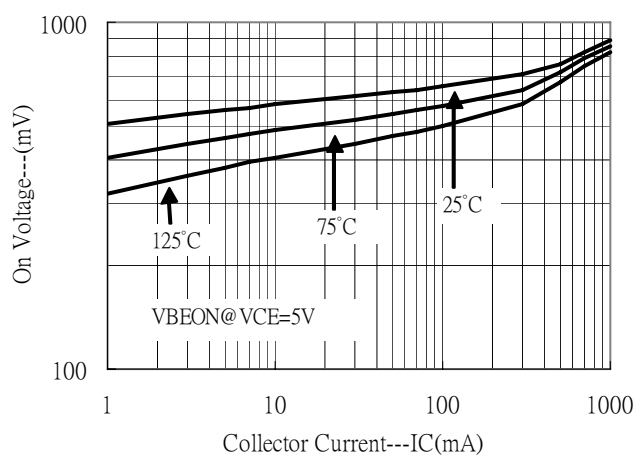



Typical Characteristics(Cont.)

Power Derating Curve

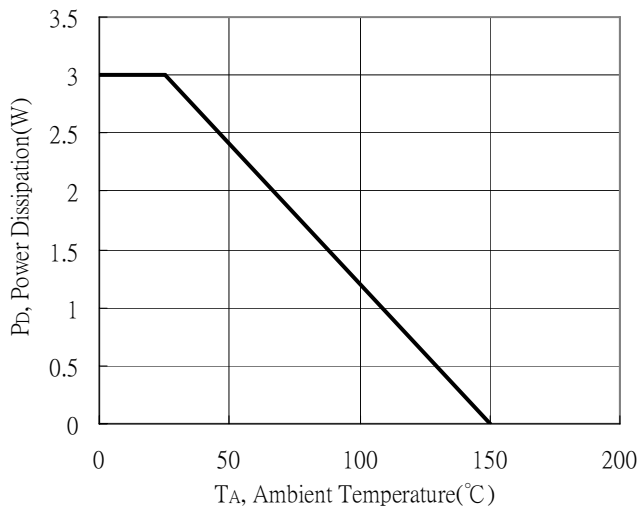

Reel Dimension

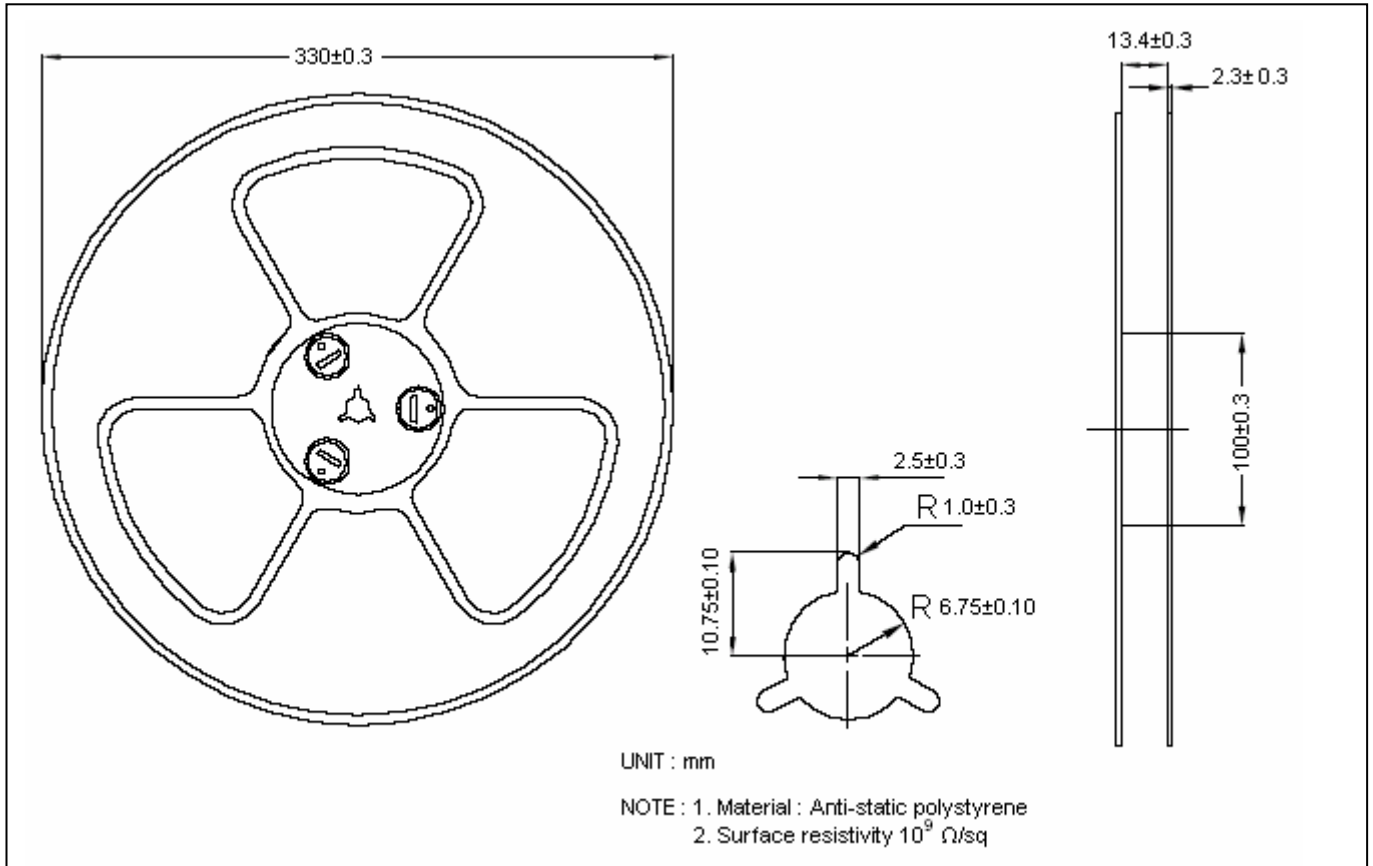

Carrier Tape Dimension

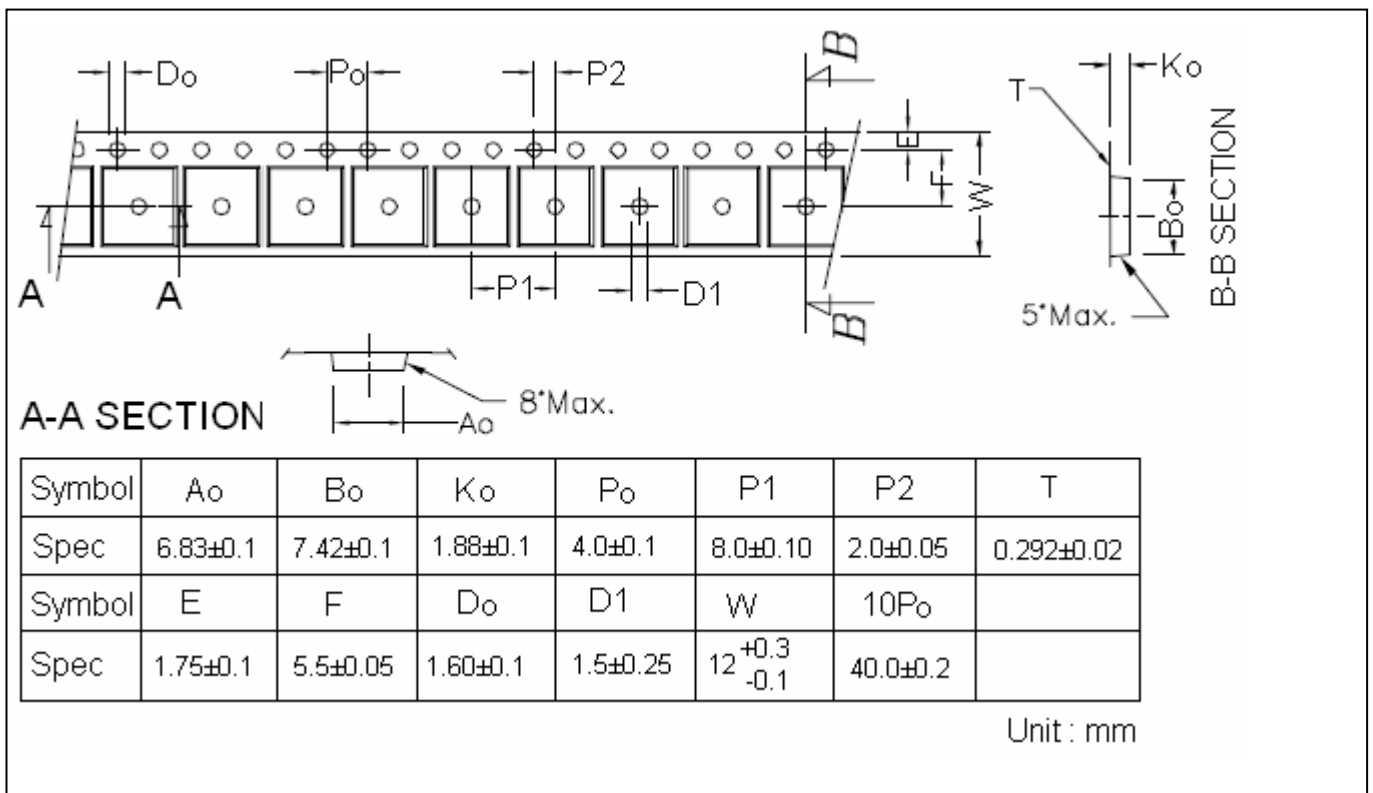

Recommended wave soldering condition

Product	Peak Temperature	Soldering Time
Pb-free devices	260 +0/-5 °C	5 +1/-1 seconds

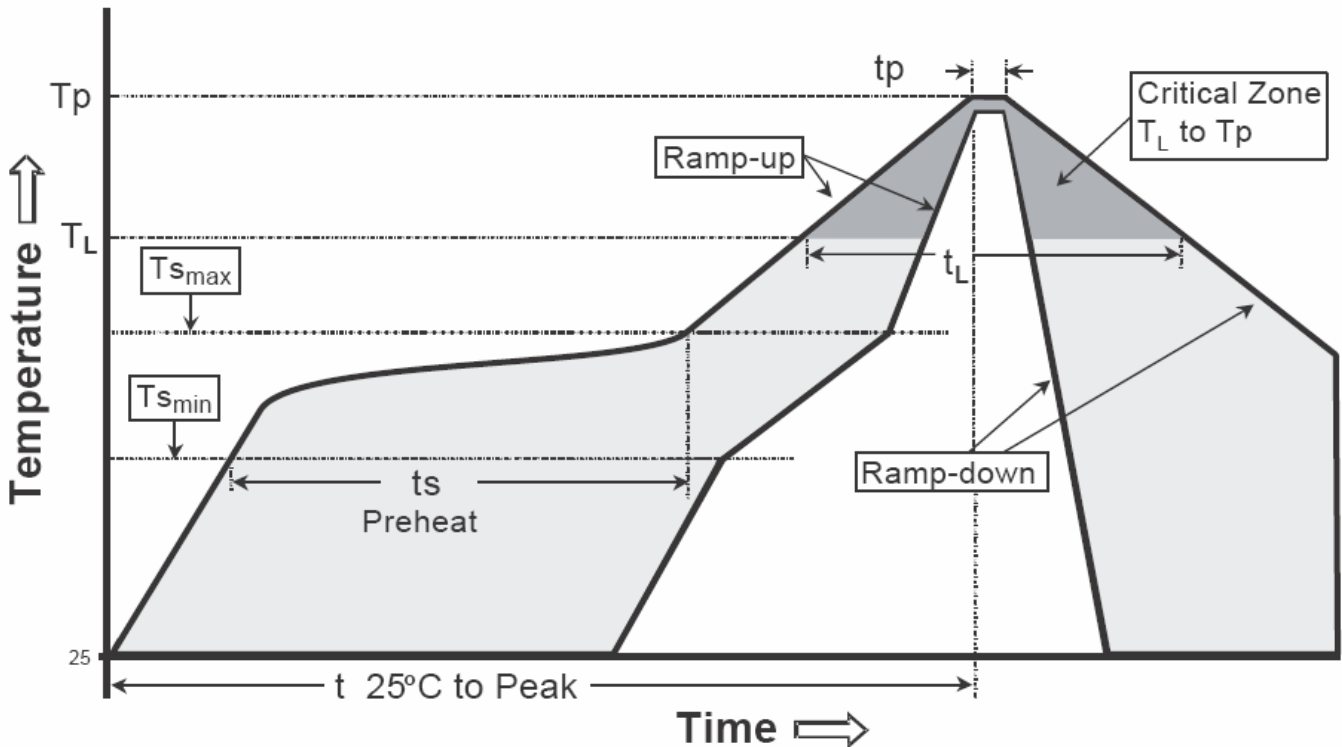
Recommended temperature profile for IR reflow

Profile feature	Sn-Pb eutectic Assembly	Pb-free Assembly
Average ramp-up rate (T _{smax} to T _p)	3°C/second max.	3°C/second max.
Preheat		
-Temperature Min(T _{s min})	100°C	150°C
-Temperature Max(T _{s max})	150°C	200°C
-Time(t _{s min} to t _{s max})	60-120 seconds	60-180 seconds
Time maintained above:		
-Temperature (T _L)	183°C	217°C
- Time (t _L)	60-150 seconds	60-150 seconds
Peak Temperature(T _P)	240 +0/-5 °C	260 +0/-5 °C
Time within 5°C of actual peak temperature(tp)	10-30 seconds	20-40 seconds
Ramp down rate	6°C/second max.	6°C/second max.
Time 25 °C to peak temperature	6 minutes max.	8 minutes max.

Note : All temperatures refer to topside of the package, measured on the package body surface.

SOT-223 Dimension

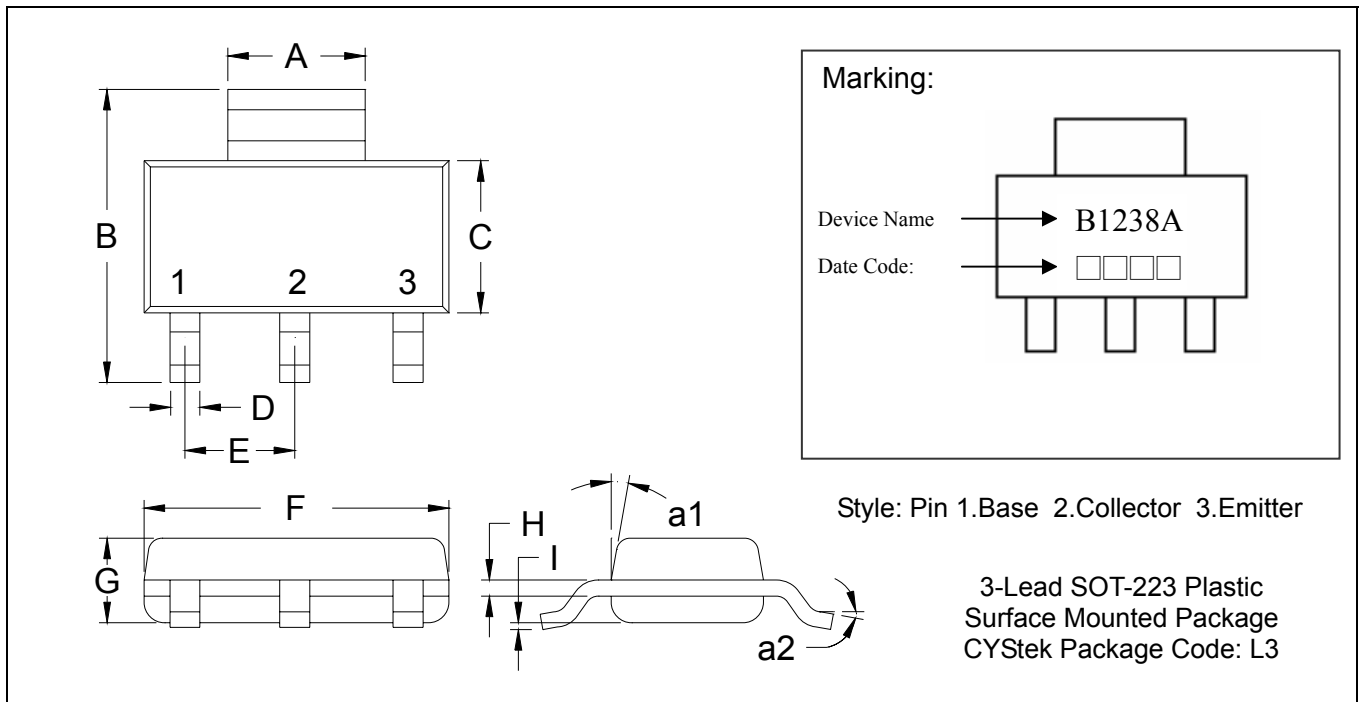

*: Typical

DIM	Inches		Millimeters		DIM	Inches		Millimeters	
	Min.	Max.	Min.	Max.		Min.	Max.	Min.	Max.
A	0.1142	0.1220	2.90	3.10	G	0.0551	0.0709	1.40	1.80
B	0.2638	0.2874	6.70	7.30	H	0.0098	0.0138	0.25	0.35
C	0.1299	0.1457	3.30	3.70	I	0.0008	0.0039	0.02	0.10
D	0.0236	0.0315	0.60	0.80	a1	*13°	-	*13°	-
E	*0.0906	-	*2.30	-	a2	0°	10°	0°	10°
F	0.2480	0.2638	6.30	6.70					

- Notes: 1.Controlling dimension: millimeters.
 2.Maximum lead thickness includes lead finish thickness, and minimum lead thickness is the minimum thickness of base material.
 3.If there is any question with packing specification or packing method, please contact your local CYStek sales office.

Material:

- Lead: Pure tin plated.
- Mold Compound: Epoxy resin family, flammability solid burning class: UL94V-0.

Important Notice:

- All rights are reserved. Reproduction in whole or in part is prohibited without the prior written approval of CYStek.
- CYStek reserves the right to make changes to its products without notice.
- CYStek **semiconductor products are not warranted to be suitable for use in Life-Support Applications, or systems.**
- CYStek assumes no liability for any consequence of customer product design, infringement of patents, or application assistance.