

400mW SOD-123 Plastic Encapsulated Diodes

1N4448WSH

Features:

- Fast switching speed
- Surface mount package suitable for automatic insertion
- For general purpose switching applications
- High conductance

Mechanical Data

- Case : SOD-123 , molded plastic
- Terminals : Solderable per MIL-STD-750 method 2026
- Polarity : Cathode indicated by polarity band.
- Flammability rating : UL94 V-0
- Package weight : approx. 0.01 gram/unit
- Mounting position : Any

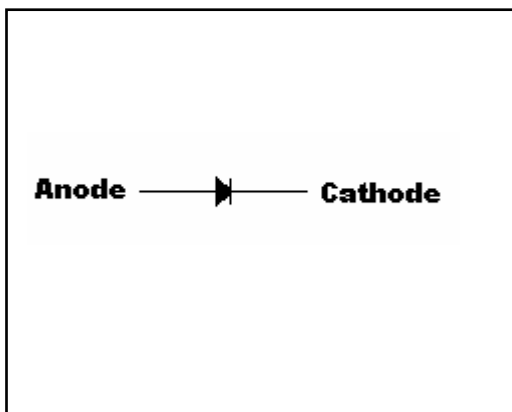
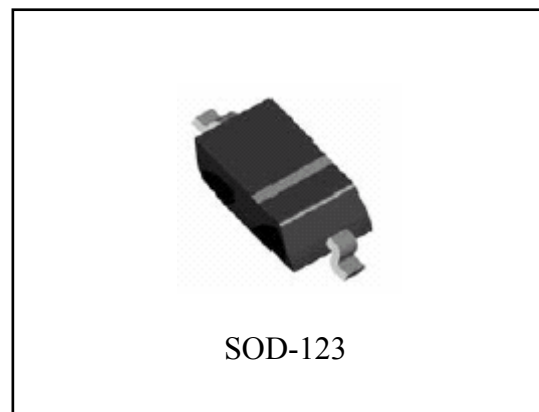
Symbol**Outline**

**Maximum Ratings**($T_A=25^{\circ}\text{C}$, unless otherwise noted)

Characteristics	Symbol	Value	Unit
Non-Repetitive Peak Reverse Voltage	V_{RM}	100	V
Repetitive Peak Reverse Voltage	V_{RRM}	100	V
DC Blocking Voltage	V_R	100	V
RMS Reverse Voltage	V_{RMS}	70	V
Forward Continuous Current	I_{FM}	500	mA
Average Forward Rectified Current	I_O	250	mA
Peak Forward Surge Current @ $t_p=1.0\mu\text{s}$ @ $t_p=1.0\text{s}$	I_{FSM}	4.0	A
		2.0	
Power Dissipation	P_D	400	mW
Junction Temperature	T_j	125	$^{\circ}\text{C}$
Storage Temperature Range	T_{stg}	-65 to +150	$^{\circ}\text{C}$

Maximum Thermal Resistance($T_A=25^{\circ}\text{C}$)

Parameter	Test Conditions	Symbol	Value	Unit
Junction to Ambient Resistance		$R_{th,JA}$	315	$^{\circ}\text{C}/\text{W}$

Electrical Characteristics ($T_A=25^{\circ}\text{C}$, unless otherwise noted)

Parameter	Conditions	Symbol	Min	Typ	Max	Unit
Forward Voltage	$I_F=5\text{mA}$	V_F	0.62	-	0.72	V
	$I_F=10\text{mA}$		-	-	0.855	
	$I_F=100\text{mA}$		-	-	1.0	
	$I_F=150\text{mA}$		-	-	1.25	
Reverse Current	$V_R=20\text{V}$	I_R	-	-	25	nA
	$V_R=100\text{V}$		-	-	2.5	μA
Reverse Breakdown Voltage	$I_R=10\mu\text{A}$	$V_{(BR)}$	100	-	-	V
Diode Capacitance	$V_R=0, f=1\text{MHz}$	C_T	-	-	4	pF
Reverse Recovery Time	$I_F=I_R=10\text{mA}, I_{RR}=0.1 \times I_R, R_L=100\Omega$	t_{rr}	-	-	4	ns

Ordering Information

Device	Package	Shipping	Marking
1N4448WSH	SOD-123 (Pb-free)	3000 pcs / Tape & Reel	T4

Characteristic Curves

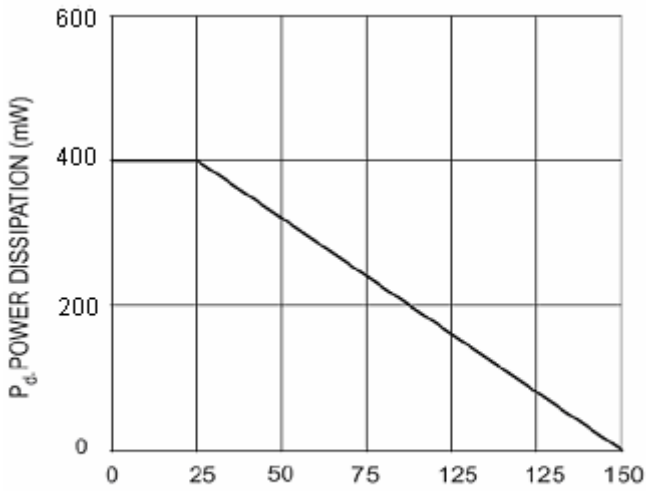

Fig. 1 Forward Current Derating Curve

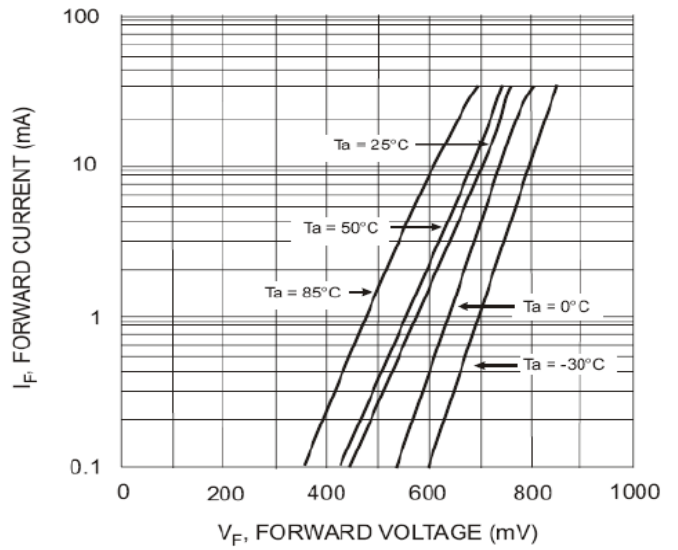

Fig. 2 Typical Forward Characteristics

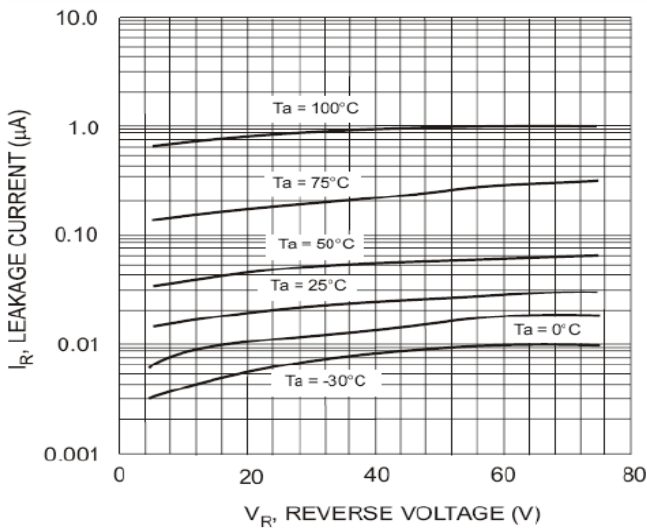

Fig. 3 Typical Reverse Characteristics

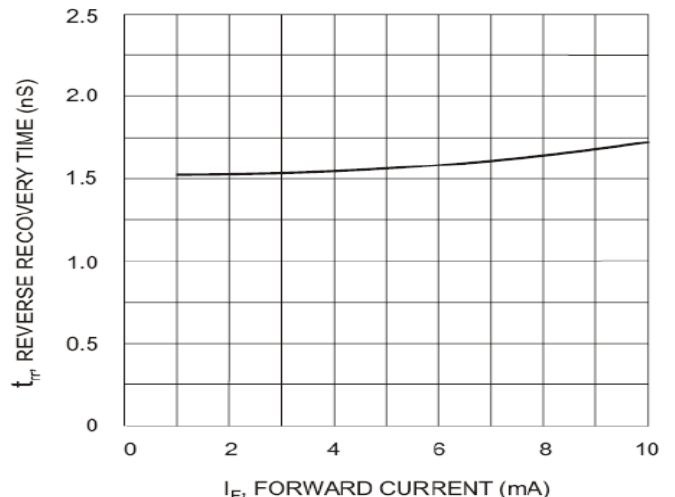

Fig. 4 Reverse Recovery Time vs. Forward Current

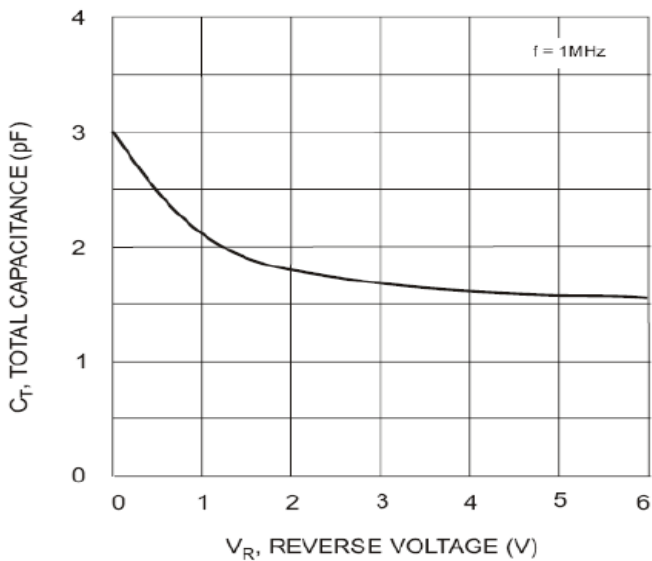
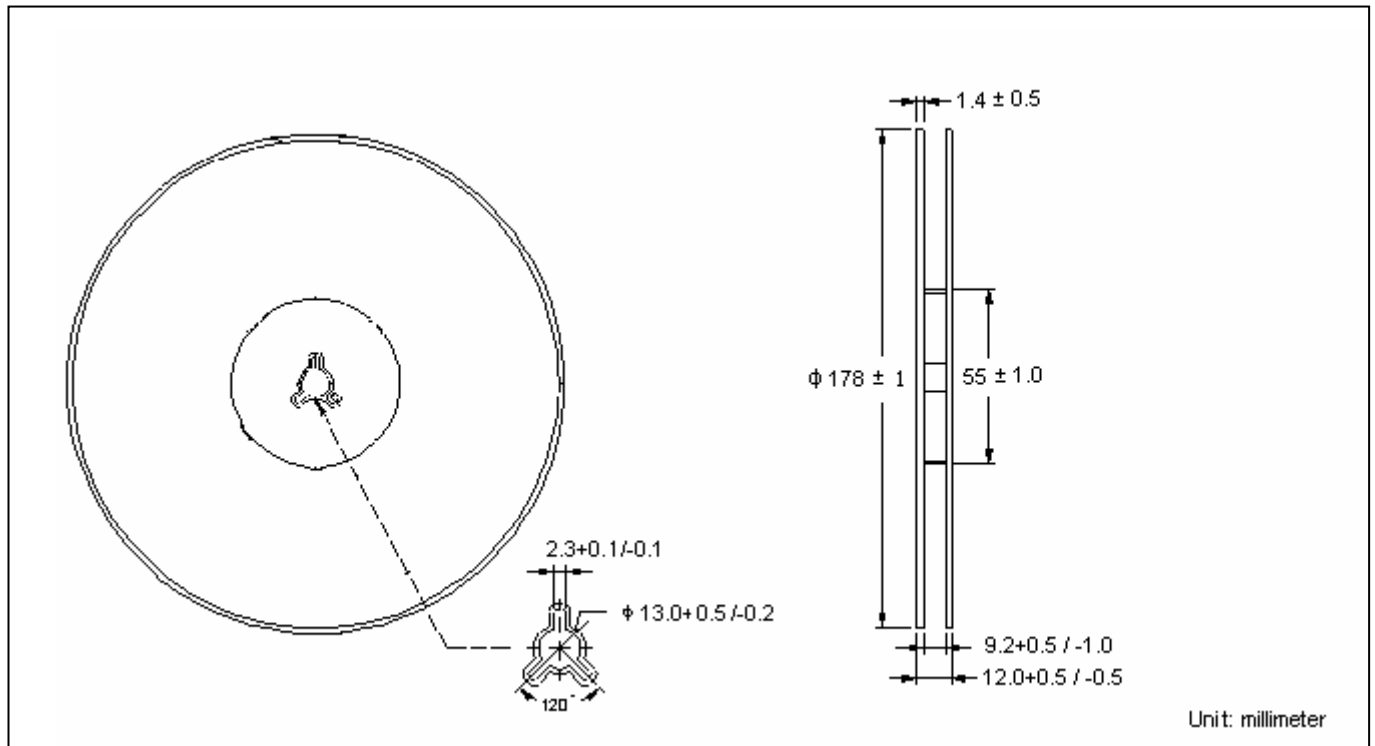
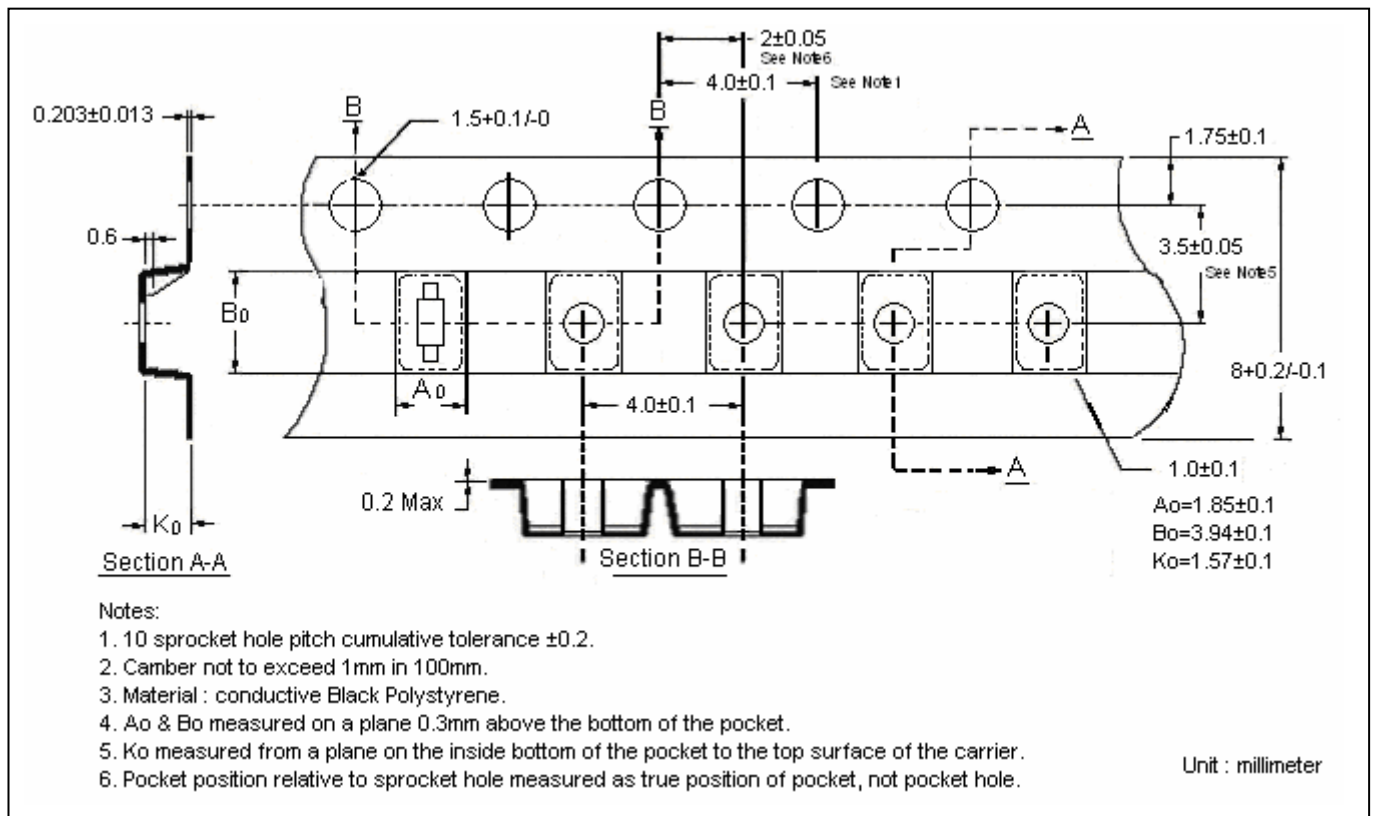

Fig. 5 Total Capacitance vs. Reverse Voltage

Reel Dimension



Carrier Tape Dimension



Recommended wave soldering condition

Product	Peak Temperature	Soldering Time
Pb-free devices	260 +0/-5 °C	5 +1/-1 seconds

Recommended temperature profile for IR reflow

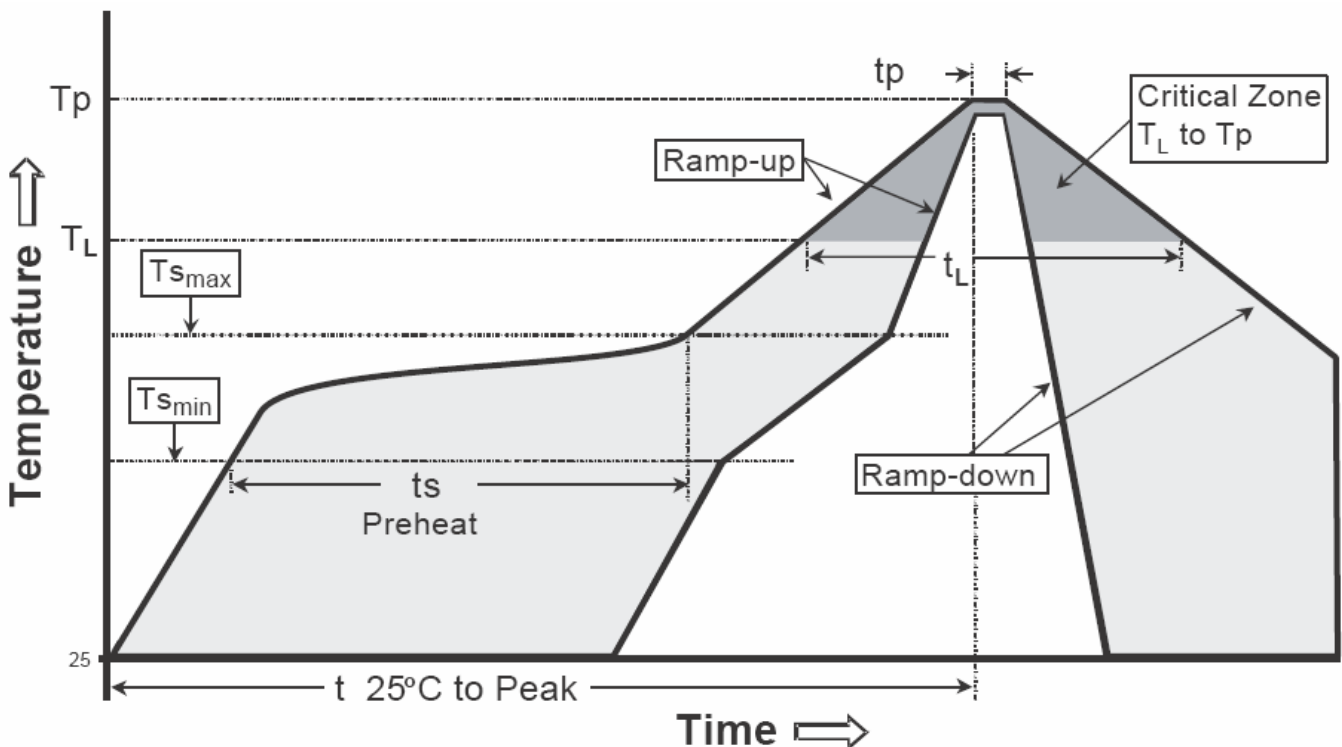

Profile feature	Sn-Pb eutectic Assembly	Pb-free Assembly
Average ramp-up rate (T _{smax} to T _p)	3°C/second max.	3°C/second max.
Preheat		
-Temperature Min(T _{s min})	100°C	150°C
-Temperature Max(T _{s max})	150°C	200°C
-Time(ts min to ts max)	60-120 seconds	60-180 seconds
Time maintained above:		
-Temperature (T _L)	183°C	217°C
- Time (t _L)	60-150 seconds	60-150 seconds
Peak Temperature(T _P)	240 +0/-5 °C	260 +0/-5 °C
Time within 5°C of actual peak temperature(tp)	10-30 seconds	20-40 seconds
Ramp down rate	6°C/second max.	6°C/second max.
Time 25 °C to peak temperature	6 minutes max.	8 minutes max.

Note : All temperatures refer to topside of the package, measured on the package body surface.

SOD-123 Dimension

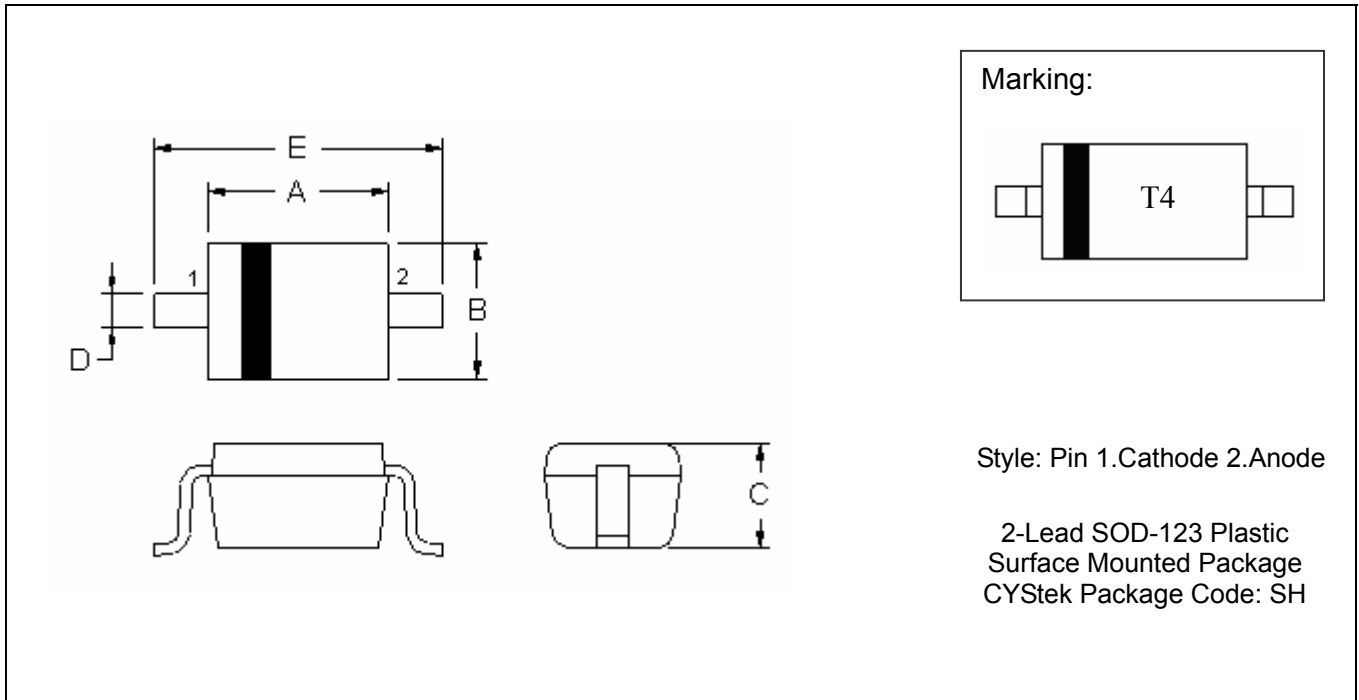

Style: Pin 1.Cathode 2.Anode

2-Lead SOD-123 Plastic
 Surface Mounted Package
 CYStek Package Code: SH

*: Typical

DIM	Inches		Millimeters		DIM	Inches		Millimeters	
	Min.	Max.	Min.	Max.		Min.	Max.	Min.	Max.
A	0.102	0.110	2.600	2.800	E	0.140	0.152	3.550	3.850
B	0.059	0.067	1.500	1.700					
C	0.041	0.049	1.050	1.250					
D	0.018	0.026	0.450	0.650					

Notes: 1.Controlling dimension : millimeters.
 2.Lead thickness specified per L/F drawing with solder plating.
 3.If there is any question with packing specification or packing method, please contact your local CYStek sales office.

Material:

- Lead: Pure tin plated.
- Mold Compound: Epoxy resin family, flammability solid burning class: UL94V-0.

Important Notice:

- All rights are reserved. Reproduction in whole or in part is prohibited without the prior written approval of CYStek.
- CYStek reserves the right to make changes to its products without notice.
- CYStek **semiconductor products are not warranted to be suitable for use in Life-Support Applications, or systems.**
- CYStek assumes no liability for any consequence of customer product design, infringement of patents, or application assistance.